

MDrive® Plus

MDO•34 Speed Control

Product overview

MDrive® Plus Speed Control products integrate 1.8° 2-phase stepper motor, programmable velocity control, drive electronics and optional encoder. Programmable velocity control uses voltage, current, or PWM analog input signal modes.

Product settings may be changed on-the-fly, or downloaded and stored in nonvolatile memory using the SPI Motor Interface software provided. This eliminates the need for external switches or resistors. Parameters are changed via an SPI port.

Application areas

MDrive Plus products deliver reliable performance for new and existing motion control applications. Satisfying the requirements for a wide range of machine builders.

Simplify your machine design and reduce cabinet size by replacing multiple components with a

single compact integrated motor. Fewer individual system components eliminates multiple potential failure points, and lowers risk of electrical noise by eliminating cabling between motor and drive.

These compact, powerful and cost effective motion control solutions deliver unsurpassed smoothness and performance that can reduce system cost, design and assembly time for a large range of 2-phase stepper motor applications.

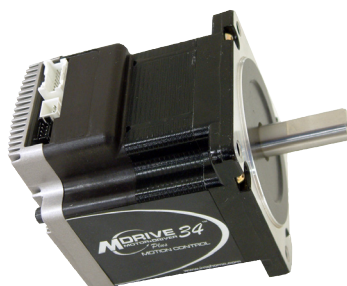

MDO•34 MDrivePlus Speed Control products: integrated NEMA34 motor and controls, IP20-rated

General features

Compact integrated microstepping drive, programmable velocity control and NEMA34 1.8° 2-phase stepper motor

Advanced current control for exceptional performance and smoothness

+12 to +75 VDC single supply

20 microstep resolutions up to 51,200 steps per rev including: Degrees, Metric, Arc Minutes

Electronically configurable

Communication SPI

Protection IP20 rating

10 bit analog speed control input 0 to +5 VDC

0 to +10 VDC

4 to 20 mA

0 to 20 mA

15 to 25 kHz PWM

Available options Motor stack lengths

Connector options

Encoders

Rear control knob for manual positioning

Graphical user interface provided for quick and easy parameter setup

MDrive Plus

MDO•34 Speed Control

Specifications

Communication	Protocol type		SPI
Input power	Voltage	VDC	+12...+75
	Current maximum (1)	Amp	4.0
Motor	Frame size	NEMA	34
		inches	3.4
		mm	85
	Holding torque	oz-in	408...1090
		N-cm	288 ... 770
	Length	stack sizes	1, 2 & 3
Thermal	Operating temp non-condensing	Heat sink maximum	75°C
		Motor maximum	90°C
Protection	Type	IP rating	IP20
		Temp warning	thermal, over voltage/current
Speed control (2)	A/D resolution		10 bit
	Input		0 to +5 VDC, 0 to +10 VDC, 0-20 mA, 4-20 mA
Logic input	Low level		0 to +0.8 VDC
	High level		+2.0 to +5.0 VDC
	Internal pull-up resistance		20 kΩ (to +3.3 VDC)
	Optically isolated		yes
	Configurable		sinking
Logic output	Step clock/direction	Open drain source maximum	+100 VDC
		Open drain current continuous	100 mA
		Output pulse width	100 nSec to 12.8 μSec software configurable
Motion	Oscillator frequency max		5 MHz
	Microstep resolution	Number of settings	20
		Steps per revolution	
Setup parameters (2)	Function	Default setting / units	Range
	ACCL/acceleration	1,000,000 steps/sec ²	91 to 1.5 X 10 ⁹
	C/joystick center (3)	0 counts	1 to 1022
	CLK OUT/clock out	none	none, step/dir, quadrature, up/down
	DB/analog deadband	1 count	0 to 255
	DECL/deceleration	500 mSec	91 to 1.5 X 10 ⁹
	DIR/motor direction override	cw	clockwise (cw)/counterclockwise (ccw)
	FAULT/checksum error	none	error code
	FS/analog full scale	1023 counts	1 to 1023
	HCDT/hold current delay time	500 milliseconds	HCDT + MSDT <= 65535
	IF/analog input filter	1 count	1 to 1000
	IMODE/analog input	A1 & A2	A1 spd/A2 spd or PWM 15 to 25 kHz
		0 to +5 VDC, volts or current	0 to +5 VDC, 0 to +10 VDC, 4 to 20 mA, 0 to 20 mA
	MHC/motor hold current	5 %	0 to 100%
	MRC/motor run current	25 %	1 to 100%
	MSDT/motor settling delay time	0 milliseconds	MSDT + HCDT <= 65535
	MSEL/μstep resolution	256 μstep per full step	1, 2, 4, 5, 8, 10, 16, 25, 32, 50, 64, 100, 108, 125, 127, 128, 180, 200, 250, 256
	STEPW/step width	550 nSec	0 (square wave), 100 nSec to 12.8 μSec
	SSD/stop/start debounce	0 milliseconds	0 to 255
	VI/initial velocity	1000 steps/sec	0 to <VM
	VM/maximum velocity	768,000 steps/sec	VI to 5,000,000
	TEMP/warning temp	80° C	0 to 85°C
	USER ID/user ID	IMS / 1-3 characters	customizable

(1) Actual power supply current will depend on voltage and load.

(2) All parameters are set using the supplied SPI Motor Interface GUI and may be changed on-the-fly. An optional Communication Converter is recommended with first orders.

(3) Separate analog inputs for A1 and A2 speeds.

MDrive Plus

MDO•34 Speed Control

Dimensions

MDO•34 NEMA34 motor, IP20-rated

inches (mm)

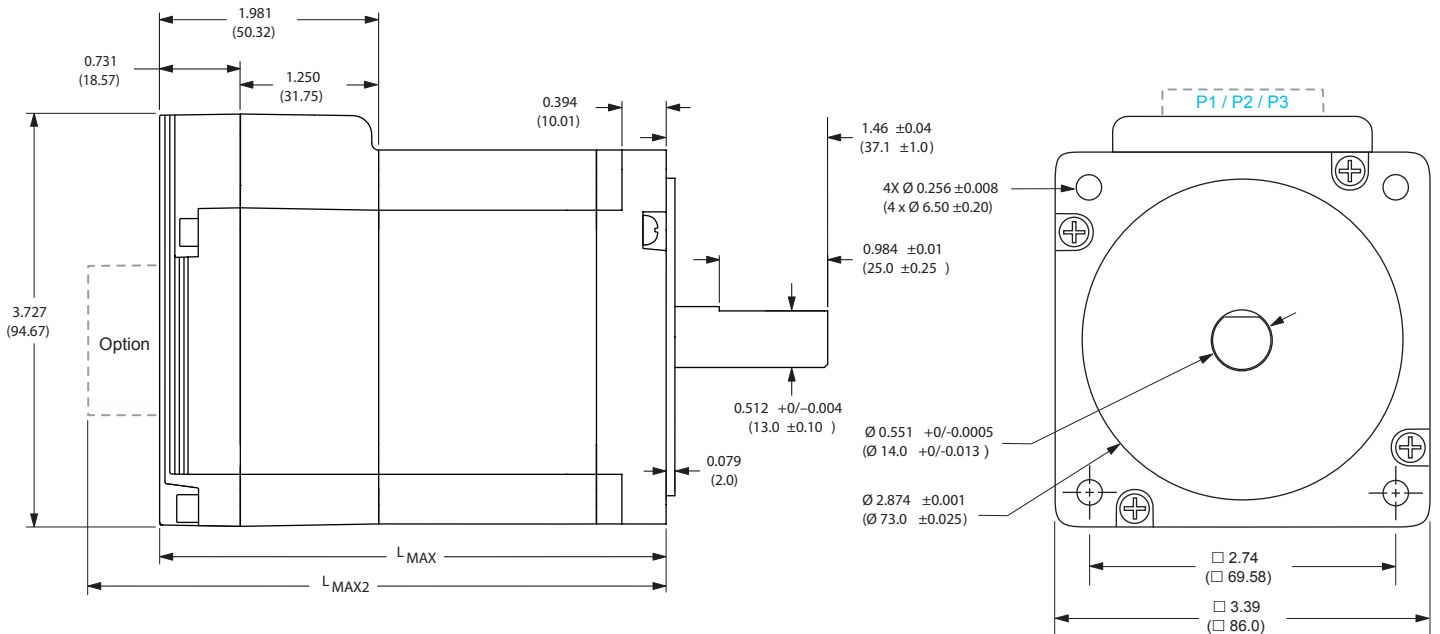

Motor stack length	Lmax	Lmax2
Single	3.81 (96.77)	4.52 (114.81)
Double	4.60 (116.84)	5.31 (134.87)
Triple	6.17 (156.72)	6.88 (174.75)

Connector options

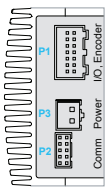

Pluggable interface version:
14-pin* and 2-pin locking wire crimp and 10-pin friction lock wire crimp connectors

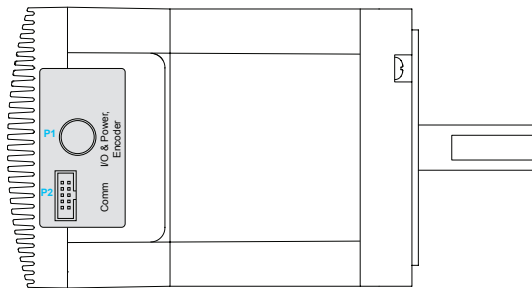

Flying leads interface version:
12* (305mm) flying leads with 10-pin non-locking IDC connector

Lmax2 option



control knob

* 12-pin replaced by 20-pin locking wire crimp connector when optional internal encoder is included

MDrive Plus

MDO•34 Speed Control

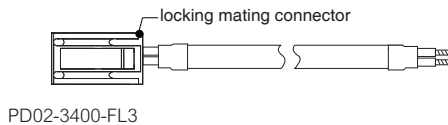
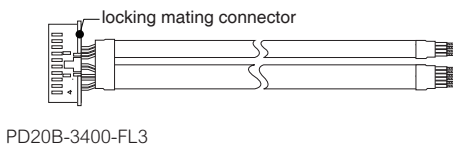
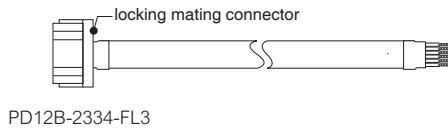
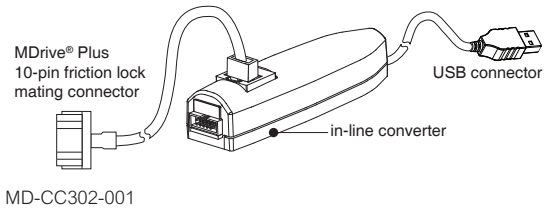
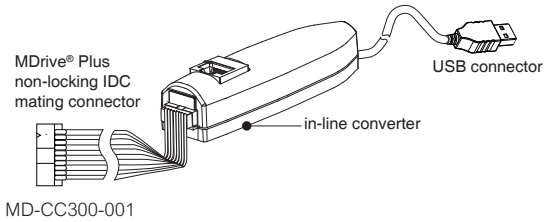

Accessories

description	length feet (m)	part number
-------------	-----------------	-------------

QuickStart Kit

For rapid design verification, all-inclusive QuickStart Kits includes prototype development cables and a communication converter for MDrivePlus initial functional setup and system testing.

For all MDrive34 Speed Control products	—	add "K" to part number
---	---	------------------------

Communication converter

Electrically isolated, in-line converter pre-wired with mating connector to conveniently set/program communication parameters for a single MDrive Plus via a PC's USB port.

Mates to 10-pin non-locking IDC connector	12.0 (3.6)	MD-CC300-001
Mates to 10-pin friction lock wire crimp connector	12.0 (3.6)	MD-CC302-001

Prototype development cable

Speed test/development with pre-wired mating connector with other cable end open.

Mates to 12-pin locking wire crimp connector for I/O	10.0 (3.0)	PD12B-2334-FL3
Mates to 20-pin locking wire crimp connector for I/O and internal encoder option	10.0 (3.0)	PD20B-3400-FL3
Mates to 2-pin locking wire crimp connector for power	10.0 (3.0)	PD02-3400-FL3

Mating connector kits

Connectors for assembly of cables, cable material not supplied. Sold in lots of 5. Manufacturer's crimp tool recommended for crimp connectors.

10-pin friction lock wire crimp connector for communication	—	CK-02
12-pin locking wire crimp connector for I/O	—	CK-08
20-pin locking wire crimp connector for I/O and internal encoder option	—	CK-11
2-pin locking wire crimp connector for power	—	CK-05
10-pin non-locking IDC connector for communication	—	CK-01

Drive protection module

Limits surge current and voltage to a safe level when DC input power is switched on-and-off to an MDrive Plus.

For all MDrive34 Speed Control products	—	DPM75
---	---	-------

MDrive Plus

MDO•34 Speed Control

MDrive® 34 Plus² IP20 flying leads interface

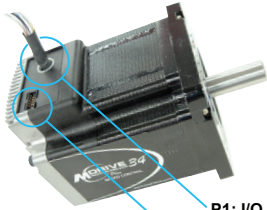

- P1: I/O & Power**
F = 12" flying leads
- P2: Communication**
D = SPI with 10-pin IDC non-locking connector

MDrive® 34 Plus² IP20 pluggable interface

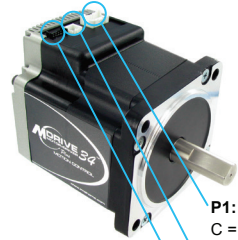

- P1: I/O and optional encoder**
C = 12-pin locking wire crimp connector (20-pin with internal encoder option)
- P3: Power**
2-pin locking wire crimp connector
- P2: Communication**
L = 10-pin friction lock wire crimp connector

Part numbers

IP20-rated products

example part number	K	M	D	O	3	F	S	D	3	4	A	7	-N
QuickStart Kit K = kit option, omit from part number if unwanted	K	M	D	O	3	F	S	D	3	4	A	7	-N
MDrivePlus version MDO = Speed Control	K	M	D	O	3	F	S	D	3	4	A	7	-N
Input 3 = Plus ² version with expanded features	K	M	D	O	3	F	S	D	3	4	A	7	-N
P1 connector F = flying leads P = pluggable	K	M	D	O	3	F	S	D	3	4	A	7	-N
Communication type S = SPI	K	M	D	O	3	F	S	D	3	4	A	7	-N
P2 connector D = IDC L = wire crimp	K	M	D	O	3	F	S	D	3	4	A	7	-N
Motor size 34 = NEMA 34 3.4" / 85mm	K	M	D	O	3	F	S	D	3	4	A	7	-N
Motor length A = single stack B = double stack C = triple stack	K	M	D	O	3	F	S	D	3	4	A	7	-N
Drive voltage 7 = +12 to +75 VDC	K	M	D	O	3	F	S	D	3	4	A	7	-N
Options — omit from part number if unwanted	K	M	D	O	3	F	S	D	3	4	A	7	-N
-N = rear control knob for manual positioning													-N
-E__ (1) = internal optical encoder w/ index mark													-E__ (1)
line count	100	200	250	256	400	500	512	1000	1024				
single-end part #	E1	E2	E3	EP	E4	E5	EQ	E6	ER				
differential part #	EA	EB	EC	EW	ED	EH	EX	EJ	EY				

(1) Products with pluggable interface available only with differential encoder.

MDrive Plus

MDO•34 Speed Control

Motor performance

MD•34 NEMA 34 motor specifications	Motor	Stack length	Single	Double	Triple
			oz-in	408	574
Holding torque		N-cm	288	405	770
		oz-in	10.9	14.16	19.83
Detent torque		N-cm	7.7	10.0	14.0
		oz-in-sec ²	0.01275	0.01924	0.03849
Rotor inertia		kg-cm ²	0.90	1.35	2.70
		lb	4.1	5.5	8.8
Weight (motor+driver)		kg	1.9	2.5	4.0

MD•34 NEMA 34 speed torque (1)

Single stack length

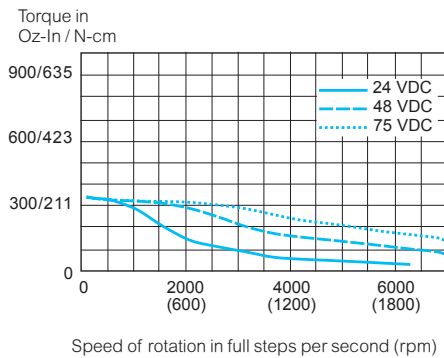

Double stack length

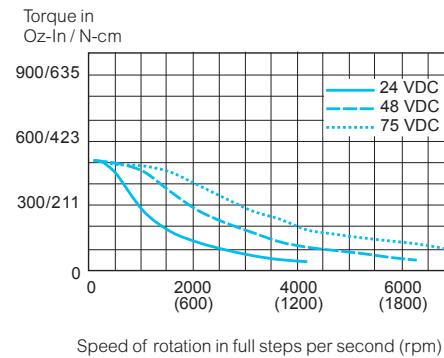

Triple stack length

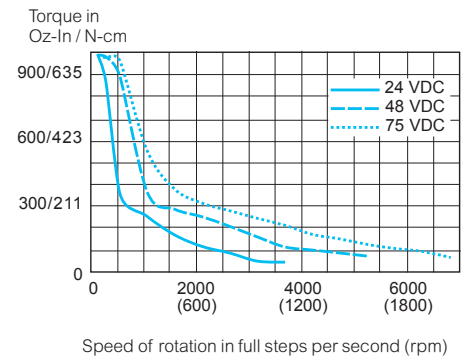

(1) Test conditions: 100% current with damper simulating load.